

HEINNER

VACUUM CLEANER

Model: HVC-V750BL

HVC-V750RD

HVC-V750OR



- Vacuum cleaner
- Power: 750W
- Suction power: > 160W

Va multumim pentru alegerea acestui produs!

I. INTRODUCTION

Before using the appliance, please read carefully this instruction manual and keep it for future reference.

This instruction manual is designed to provide you with all required instructions related to the installation, use and maintenance of the appliance.

In order to operate the unit correctly and safety, please read this instruction manual carefully before installation and usage.

II. PACKAGE CONTENT

- Vacuum cleaner
- Floor brush
- Nozzle
- User manual
- Warranty card



III. DESCRIPTION OF THE APPLIANCE

1. Modern and elegant design
2. Multiple air-filter system guarantees a hygienic cleaning
3. Drivers accessories: floor brush, nozzle etc
4. User-friendly wire rewriter pedal

IV. KNOW YOUR VACUUM CLEANER

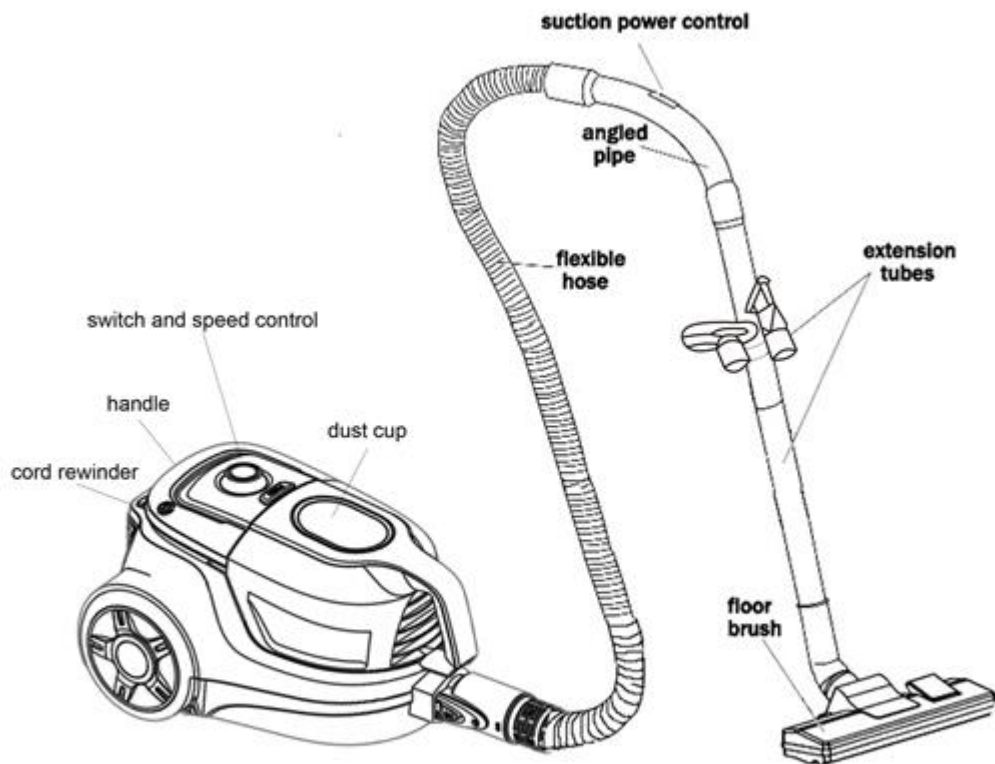

V. IMPORTANT SAFETY INSTRUCTIONS

This appliance is not intended for use by persons (including children) with reduced physical, sensory or mental capabilities, or lack of experience and knowledge, unless they have been given supervision or instruction concerning use of the appliance by a person responsible for their safety.

Children should be supervised to ensure that they do not play with the appliance.



If the supply cord is damaged, it must be replaced by the manufacture or its service agent or a similarly qualified person in order to avoid a hazard. For household use, only. Do not use for absorbing detergent, kerosene, glass, needle, cigarette ash, water, match etc.

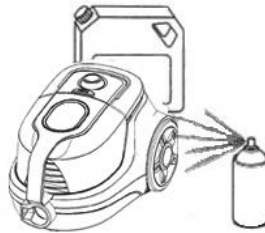

The appliance should not be exposed to heat

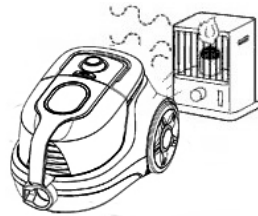

Unplug the appliance from the mains supply. Socket after use and before every cleaning pull the mains cable, in order to disconnect the appliance from the mains.

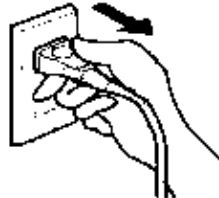

Do not put any object into openings. Do not use with any opening blocked. Keep the appliance free of dust, lint, hair etc.

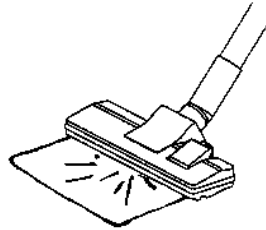

Do not use the vacuum cleaner without dust container or dust filter in place.

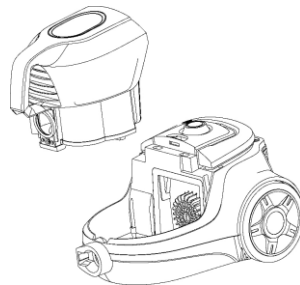

Do not vacuum any flour, cement etc, in order to avoid the overloads.

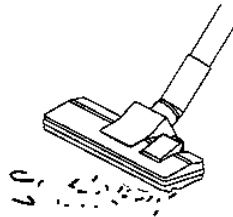

The appliance should only be cleaned with a dry or damp cloth, it should never have immersed in water. Do not use any solvents for cleaning.



VI. ASSEMBLY VACUUM CLEANER

Connect the hose with vacuum cleaner

Insert flexible hose into the air-intake: Press the knob until it clicks into the position

Remove the flexible hose: Unplug the appliance and press the knob at the end of the hose. Remove it from the air-intake opening.

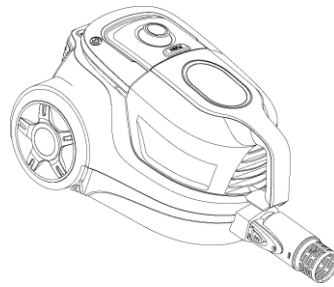

Fit the telescopic to the angled pipe.

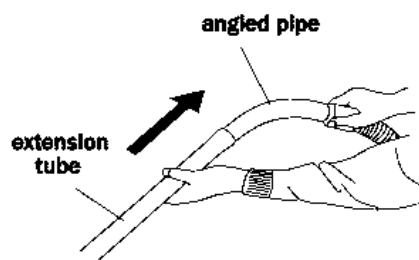

Fit the floor brush to the telescopic tube.

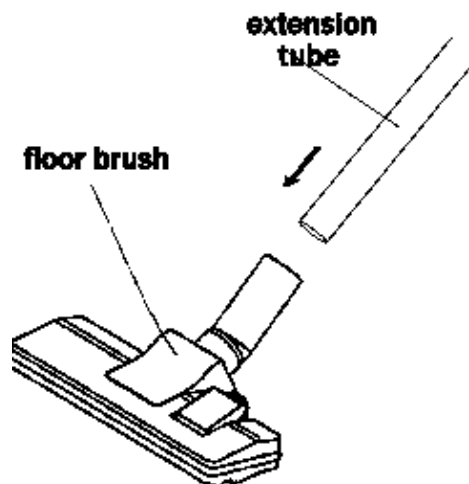

VII. OPERATION

A yellow mark on power cord shows the ideal cable length. Do not extend the cable beyond the red mark. To rewind the power cord, press the rewriter pedal with one hand and guide the cord with the other hand.

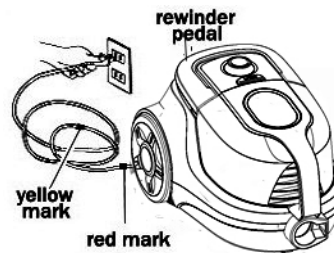

Press the power switch to switch the appliance on. Use the electronic speed adjusting to control the suction power of the cleaner.

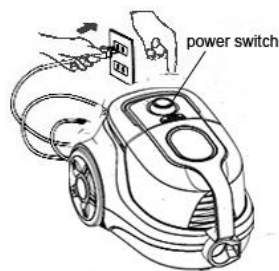

The suction power can be adjusted with the sliding control on the angled pipe too.

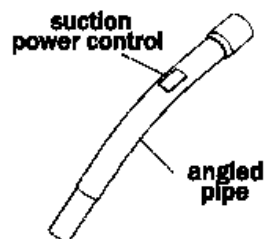

Put the telescopic tube into the fixing hook of the appliance when you have a break.
Caution: Do not transfer the appliance when the fixing hook is used.

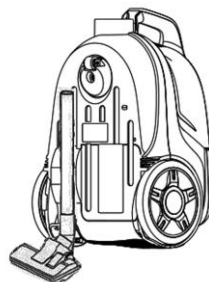

VIII. CLEANING TOOLS

Crevice tool:

For cleaning corner edge and draws etc:

Where is difficult to reach, such as gaps and the keyboard, bookshelf and windows.

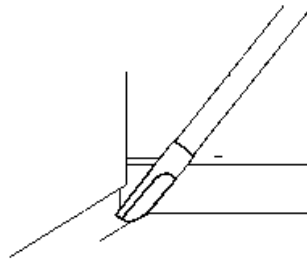

Sofa brush: For cleaning bed, sofa, couch etc.

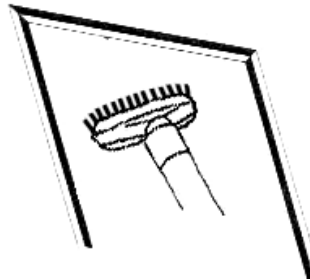

Use of the selector on floor brush: Bristles extended for carpets. Bristles retracted for hard floors.

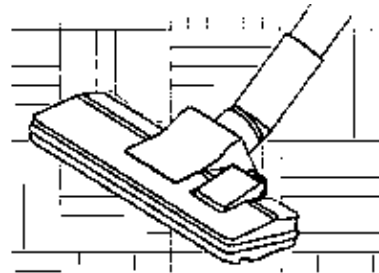
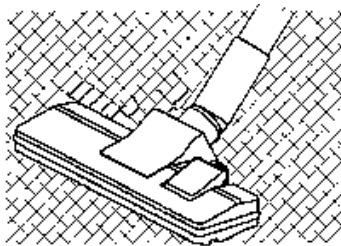

If the angled pipe has blockage. Insert it into the air-intake and switch the appliance on.

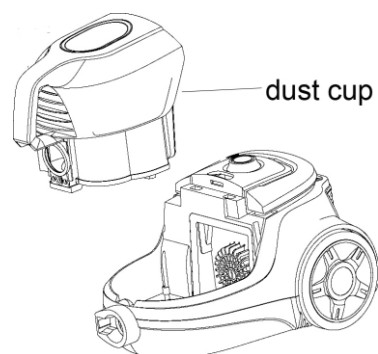

IX. CLEANING AND MAINTENANCE

Empty the dust container

1. After removing the flexible hose, press the cover lock button and open the dust container.
2. Remove the dust filter from the container.
3. Replace the dust filter in the container.
4. Close the dust container until it is locked in the position.

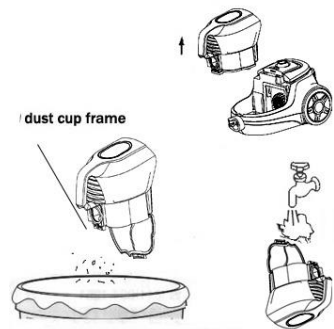

Change filter

Replace the motor filter: Open the dust container and remove the motor filter. Fix the new filter in the position.

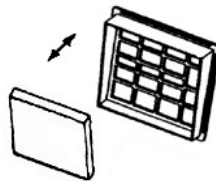

Replace the outlet filter: Detach the grille by pulling firmly away from the appliance, remove the outlet filter and replace the new filter. Fix the grille again.

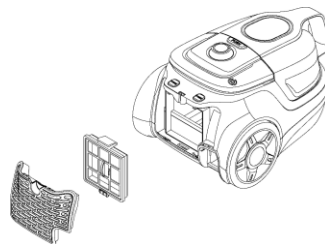

Clean the filter: Clean the filter in water and allow them to dry completely before replace them.

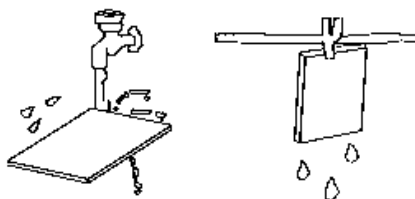

X. ERROR DETECTION

Before you contact our services center, please check the following points:

| Problem | Possible reason | Active |
|--|--|--|
| Motor does not start | -Power card not firmly plugged into outlet -Outlet damaged -Cleaner not switch on | -Plug unit firmly -Check the outlet -Switch on the appliance. |
| Suction power is weaker | -unit clogged -Dust filter needs cleaning -Dust container not in position -Filter blocked | -Remove the blockage -Clean the dust filter -Close the dust container -Clean the filter |
| The wire can not be winded completely. | The wire may diverge the wire wheel. | Draw the wire a little then rewind. |
| The wire can not be draw out. | The wire may wind disorder | Press the rewinder button and try again. |
| Speed adjust does not work | Appliance is defective | Repair the appliance (only specialist) |
| Power card winds unwanted back | Rewind mechanisms is defective | Repair the appliance (only specialist) |
| The dust container can not be closed | Dust filter is not in the position | Fix the dust filter and try again |

Warning:

If the supply card is damaged, it must be replaced by the manufacturer or its server agent or a similarly qualified person in order to avoid a hazard.

XI. TECHNICAL DETAILS

| | |
|-----------------------|------------------|
| Power | 750W |
| Suction power | > 160W |
| Voltage: | 220-240V~50/60Hz |
| Noise level | 75dB |
| Dust capacity: | 2.2 L |



Environment friendly disposal

You can help protect the environment!

Please remember to respect the local regulations: hand in the non-working electrical equipment's to an appropriate waste disposal center.



HEINNER is a registered trademark of **Network One Distribution SRL**. Other brands and product names are trademarks or registered trademarks of their respective holders.

No part of the specifications may be reproduced in any form or by any means or used to make any derivative such as translation, transformation, or adaptation without permission from NETWORK ONE DISTRIBUTION.

Copyright © 2013 Network One Distribution. All rights reserved.

www.heinner.com, <http://www.nod.ro>

<http://www.heinner.com>, <http://www.nod.ro>



This product is in conformity with norms and standards of European Community.

Importer: **Network One Distribution**

Marcel Iancu Street, 3-5, Bucharest, Romania

Tel: +40 21 211 18 56, www.heinner.ro, www.heinner.com

HEINNER

ASPIRATOR FARA SAC

Model: HVC-V750BL

HVC-V750RD

HVC-V750OR



- Aspirator
- Putere: 750 W
- Capacitate de absorbtie: > 160 W

Vă mulțumim pentru alegerea acestui produs!

I. INTRODUCERE

Înainte de a utiliza acest aparat, citiți cu atenție manualul de instrucțiuni și păstrați-l pentru consultări ulterioare.

Acest manual este conceput pentru a vă oferi toate instrucțiunile necesare referitoare la instalarea, utilizarea și întreținerea aparatului.

Pentru utilizarea corectă și în siguranță a aparatului, vă rugăm să citiți cu atenție acest manual de instrucțiuni înainte de instalare și utilizare.

II. CONȚINUTUL PACHETULUI DUMNEAVOASTRĂ



- Aspirator
- Perie pentru podele
- Duză
- Manual de utilizare
- Certificat de garanție

III. DESCRIEREA APARATULUI

1. Design modern și elegant
2. Sistemul de filtrare a aerului asigură o curățare igienică
3. Accesorii: perie pentru podele, duză etc.
4. Pedală pentru rularea cablului poziționată ergonomic

IV. DESCRIERE

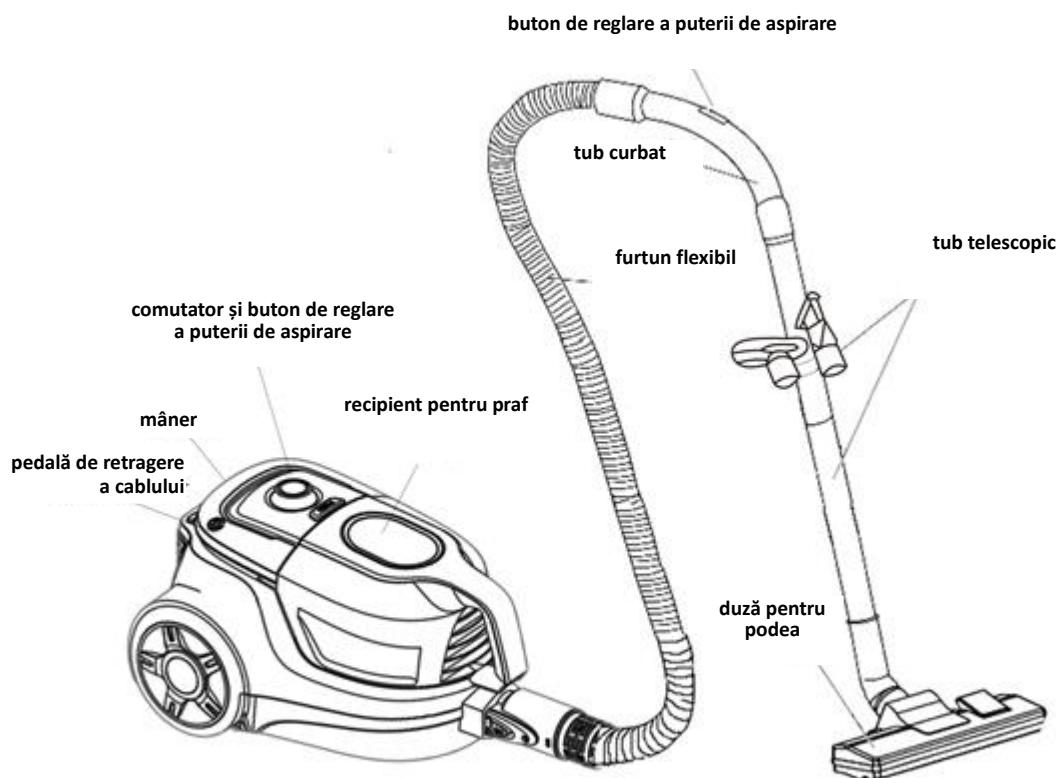

V. INSTRUCȚIUNI IMPORTANTE CU PRIVIRE LA SIGURANȚĂ

Aparatul nu este destinat utilizării de către persoane (inclusiv copii) care au capacități fizice, senzoriale sau mentale reduse, sau cărora le lipsesc experiența și cunoștințele necesare, decât dacă sunt supravegheate sau au fost instruite cu privire la utilizarea aparatului de către o persoană care răspunde de siguranța acestora.

Copiii trebuie supravegheați, astfel încât aceștia să nu se joace cu aparatul.



Pentru evitarea pericolelor, în cazul în care cablul de alimentare este deteriorat, acesta trebuie înlocuit de către producător, de către agentul său de service sau de persoane cu o calificare similară. Acest aparat este numai pentru uz casnic.

Nu aspirați detergent, benzină, sticlă, ace, cenușă, scrum de țigară, apă, chibrituri etc.

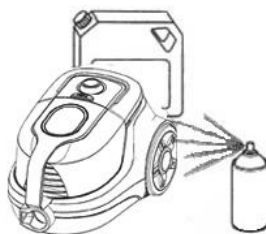

Aparatul nu trebuie expus la căldură.

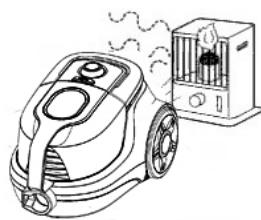

Deconectați aparatul de la sursa de alimentare cu energie electrică.

După utilizare și înainte de efectuarea oricăror operații de curățare a aparatului, scoateți cablul din priză pentru a deconecta aparatul de la sursa de alimentare cu energie electrică.

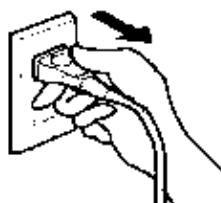

Nu introduceți obiecte în orificiile aparatului. Nu utilizați aparatul dacă oricare dintre orificiile acestuia este blocat. Curățați aparatul de praf, scame, păr etc.

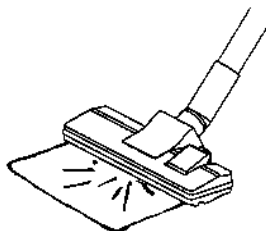

Nu utilizați aparatul fără a avea montat recipientul pentru praf sau filtrul.

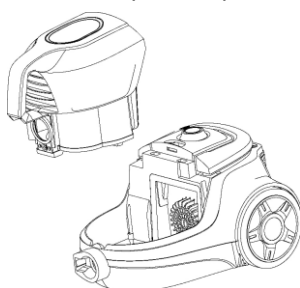

Pentru a evita supraîncărcarea, nu aspirați făină, ciment etc.

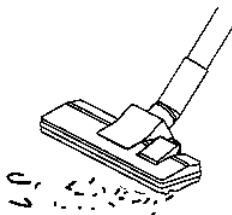

Aparatul trebuie curățat numai cu o cârpă uscată sau umedă; aparatul nu trebuie scufundat în apă. Nu folosiți solvenți pentru curățare.



VI. ASAMBLAREA ASPIRATORULUI

Conectarea furtunului la aspirator

Introduceți furtunul flexibil în orificiul de aspirație. Apăsați butonul până când se fixează în poziție.

Scoaterea furtunului flexibil: Scoateți ștecăruș din priză și apăsați butonul de la capătul furtunului. Scoateți furtunul din orificiul de aspirație.

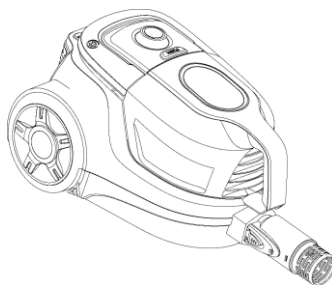

Montați tubul telescopic în tubul curbat.

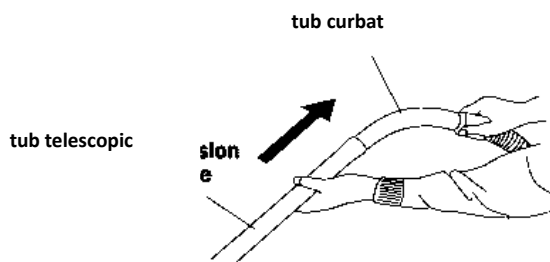

Fixați peria de podea în tubul telescopic.

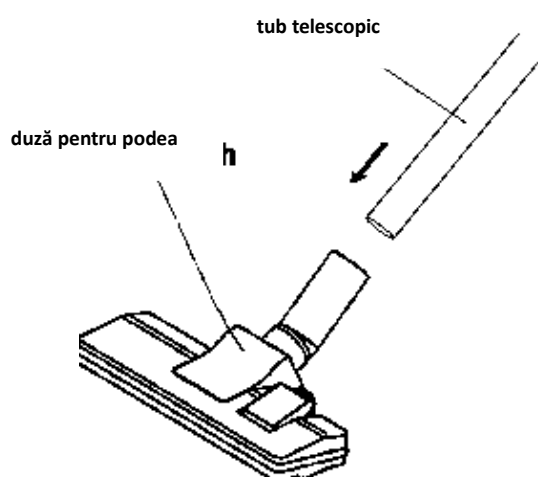

VII. FUNCȚIONARE

Semnul galben de pe cablul de alimentare indică lungimea recomandată a cablului. Nu extindeți cablul dincolo de semnul roșu. Pentru a retrage cablul de alimentare, apăsați pedala cu o mână și ghidați cablul cu cealaltă mână.

pedală de retragere a cablului

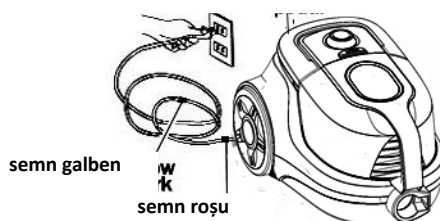

Apăsați butonul de PORNIRE/OPRIRE pentru a porni aparatul. Utilizați butonul pentru reglarea electronică a puterii de aspirare.

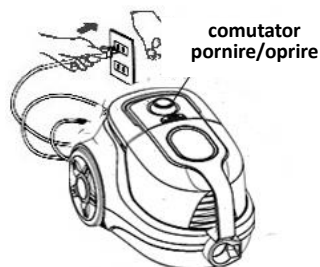

Puterea de aspirare poate fi reglată și cu ajutorul clapetei glisante de pe tubul curbat.

buton de reglare a puterii de aspirare

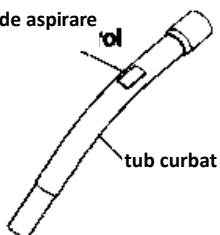

Atunci când luați o pauză, puteți pune tubul telescopic în cârligul de fixare. Atenție: Nu transportați aparatul în timpul utilizării cârligului de fixare.

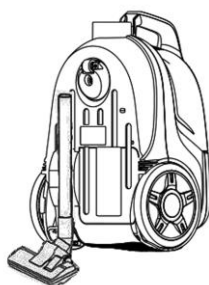

VIII. ACCESORII PENTRU CURĂȚARE

Accesoriu pentru spații înguste:

Acest accesoriu poate fi utilizat pentru aspirarea în colțurile camerelor, în setare, în spațiile dintre articole de mobilier, pentru curățarea tastaturilor, a rafturilor și a ferestrelor.

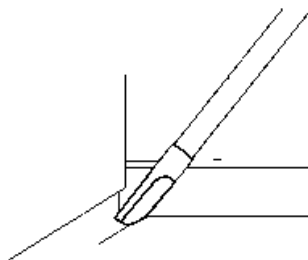

Perie pentru canapele: Pentru curățarea paturilor, canapelelor etc.

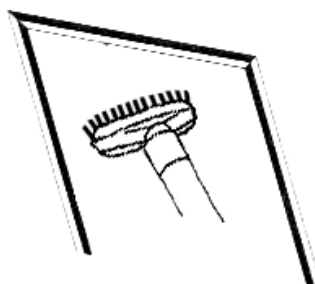

Utilizarea pedalei pentru extinderea periei: Peria se extinde în cazul curățării covoarelor. Peria nu se extinde în cazul curățării podelelor.

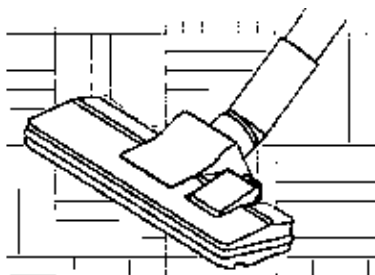
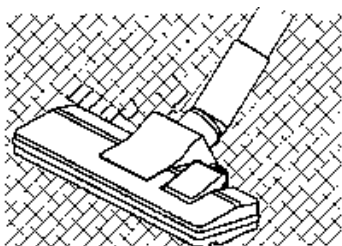

Dacă tubul curbat se înfundă, introduceți-l în orificiul de aspirație și porniți aparatul.

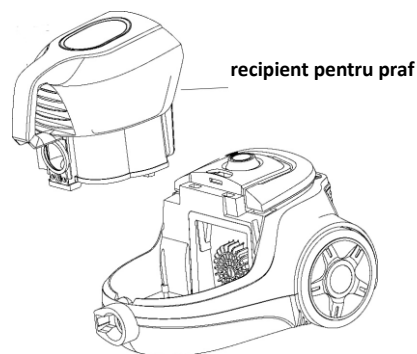

IX. CURĂȚARE ȘI ÎNTREȚINERE

Golirea recipientului pentru praf

1. După scoaterea furtunului flexibil, apăsați butonul de blocare a capacului și deschideți recipientul pentru praf.
2. Scoateți filtrul de praf din recipient.
3. Repoziționați filtrul de praf în recipient.
4. Închideți recipientul pentru praf.

carcasa recipientului pentru praf

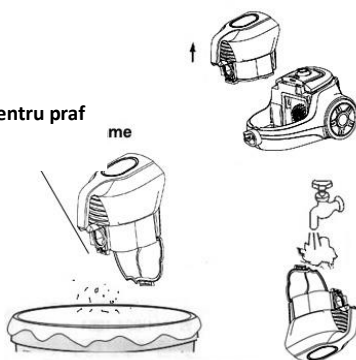

Înlocuirea filtrului

Înlocuirea filtrului motorului: Deschideți recipientul pentru praf și scoateți filtrul motorului. Fixați un nou filtru în poziție.

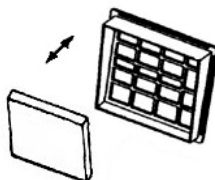

Înlocuirea filtrului de evacuare: Desfaceți grila prin tragere, scoateți filtrul de evacuare și înlocuiți-l cu un filtru nou. Montați grila la loc.

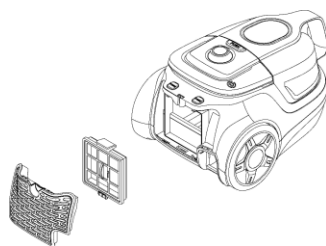

Curățarea filtrului: Curățați filtrul cu apă și lăsați-l să se usuce complet înainte de a-l monta la loc.

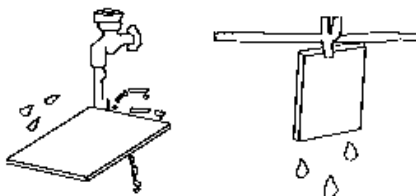

X. DEPISTAREA PROBLEMELOR

Înainte de contactarea centrului de reparații, verificați următoarele:

| Problemă | Motive posibile | Măsuri necesare |
|---|---|--|
| Motorul nu pornește | <ul style="list-style-type: none"> - Ștecărul nu este conectat corespunzător la priză - Priza este defectă - Aparatul nu este pornit | <ul style="list-style-type: none"> - Conectați corespunzător ștecărul - Verificați priza - Porniți aparatul |
| Puterea de aspirare este redusă | <ul style="list-style-type: none"> - Aparatul este înfundat. - Filtrul de praf necesită curățare. - Recipientul pentru praf nu este montat în poziția corectă - Filtrul este blocat | <ul style="list-style-type: none"> - Înlăturați cauza blocajului - Curățați filtrul de praf - Închideți recipientul pentru praf - Curățați filtrul |
| Cablul nu poate fi retras complet. | Cablul poate ieși de pe rolă. | Trageți puțin de cablu, apoi lăsați-l să se retragă. |
| Cablul nu poate fi scos din aparat. | Cablul poate fi încurcat pe rolă. | Apăsăți butonul de retragere a cablului și încercați din nou. |
| Reglarea puterii de aspirare nu funcționează | Aparatul este defect | Duceți aparatul la reparaț (la un specialist) |
| Cablul de alimentare se retrage singur, fără apăsarea butonului | Mecanismul de retragere a cablului este defect | Duceți aparatul la reparaț (la un specialist) |
| Recipientul pentru praf nu poate fi închis. | Filtrul de praf nu este fixat corespunzător | Fixați filtrul de praf și încercați din nou |

Avertisment:

Pentru evitarea pericolelor, în cazul în care cablul de alimentare este deteriorat, acesta trebuie înlocuit de către producător, de către agentul său de service sau de persoane cu o calificare similară.

XI. DETALII TEHNICE

| | |
|---|------------------|
| Putere | 750W |
| Putere de aspirare | > 160W |
| Alimentare: | 220-240V~50/60Hz |
| Nivel de zgomot | 75 dB |
| Capacitatea recipientului pentru praf: | 2.2 L |



INFORMATII PRIVIND DESEURI DE ECHIPAMENTE ELECTRICE SI ELECTRONICE (DEEE)

Deseurile de echipamente electrice si electronice (DEEE) pot contine substante periculoase ce au un impact negativ asupra mediului si sanatatii umane, in cazul in care nu sunt colectate separat.

Acest produs este conform cu Directiva UE DEEE (2012/19/UE) si este marcat cu un simbol de clasificare a deșeurilor de echipamente electrice și electronice (DEEE), reprezentat grafic in imaginea alaturata.



Aceasta pictograma indica faptul ca DEEE nu trebuie amestecate cu deseurile menajere si ca ele fac obiectul unei colectari separate.

Avand in vedere prevederile OUG 195/2005 – referitoare la protectia mediului si O.U.G. 5/2015 privind deseurile de echipamente electrice si electronice, va recomandam sa aveti in vedere urmatoarele:

- Materialele si componentele folosite la constructia acestui produs sunt materiale de înaltă calitate, care pot fi refolosite și reciclate.
- Nu aruncați produsul împreună cu gunoierul menajer sau cu alte gunoieruri la sfârșitul duratei de exploatare.
- Transportați-l la centrul de colectare pentru reciclarea echipamentelor electrice și electronice unde va fi preluat in mod gratuit.
- Va rugam sa luați legătura cu autoritățile locale pentru detalii despre aceste centre de colectare organizate de operatorii economici autorizati pentru colectarea DEEE.

Conformitatea cu directiva RoHS: Produsul pe care l-ați cumpărat este conform cu Directiva RoHS UE (2011/65/UE). Nu conține materialele dăunătoare și interzise specificate în Directivă.

Va multumim ca participati alaturi de noi la protejarea mediului si a sanatatii umane!



HEINNER este marcă înregistrată a companiei **Network One Distribution SRL**. Celelalte branduri și denumirile produselor sunt mărci de comerț sau mărci de comerț înregistrate ale respectivilor deținători.

Nicio parte a specificațiilor nu poate fi reprodusă, sub nicio formă și prin niciun mijloc, nici utilizată pentru obținerea unor derivate precum traduceri, transformări sau adaptări, fără consimțământul prealabil al companiei NETWORK ONE DISTRIBUTION.

Copyright © 2013 Network One Distribution. Toate drepturile rezervate.

www.heinner.com, <http://www.nod.ro>

<http://www.heinner.com>, <http://www.nod.ro>



Acest produs este proiectat și realizat în conformitate cu standardele și normele Comunității Europene.

Importator: **Network One Distribution**

Str. Marcel Iancu, nr. 3-5, București, România

Tel: +40 21 211 18 56, www.heinner.ro, www.heinner.com

HEINNER

ПРАХОСМУКАЧКА

Модел: HVC-V750BL

HVC-V750RD

HVC-V750OR



- Прахосмукачка
- Мощност: 750 W
- Всмукателна мощност: > 160 W

Благодарим Ви, че избрахте този продукт!

I. ВЪВЕДЕНИЕ

Преди да използвате този уред прочетете внимателно този наръчник с инструкции и пазете го за бъдещи справки.

Този наръчник е проектиран, за да Ви предостави всички необходими инструкции относно инсталирането, използването и поддържането на уреда.

Преди инсталиране и използване на уреда, с цел правилна и безопасна употреба на уреда, моля прочетете внимателно този наръчник с инструкции.

II. СЪДЪРЖАНИЕ НА ВАШИЯ КОМПЛЕКТ

- Прахосмукачка
- Четка за подове
- Приставка
- Наръчник за употреба
- Сертификат за гаранция



III. ОПИСАНИЕ НА УРЕДА

1. Модерен и елегантен дизайн
2. Системата за филтриране на въздуха осигурява хигиенично почистване
3. Аксесоари: четка за под, приставка и др.
4. Ергономично позиционирано копче за прибиране на кабела

IV. ОПИСАНИЕ

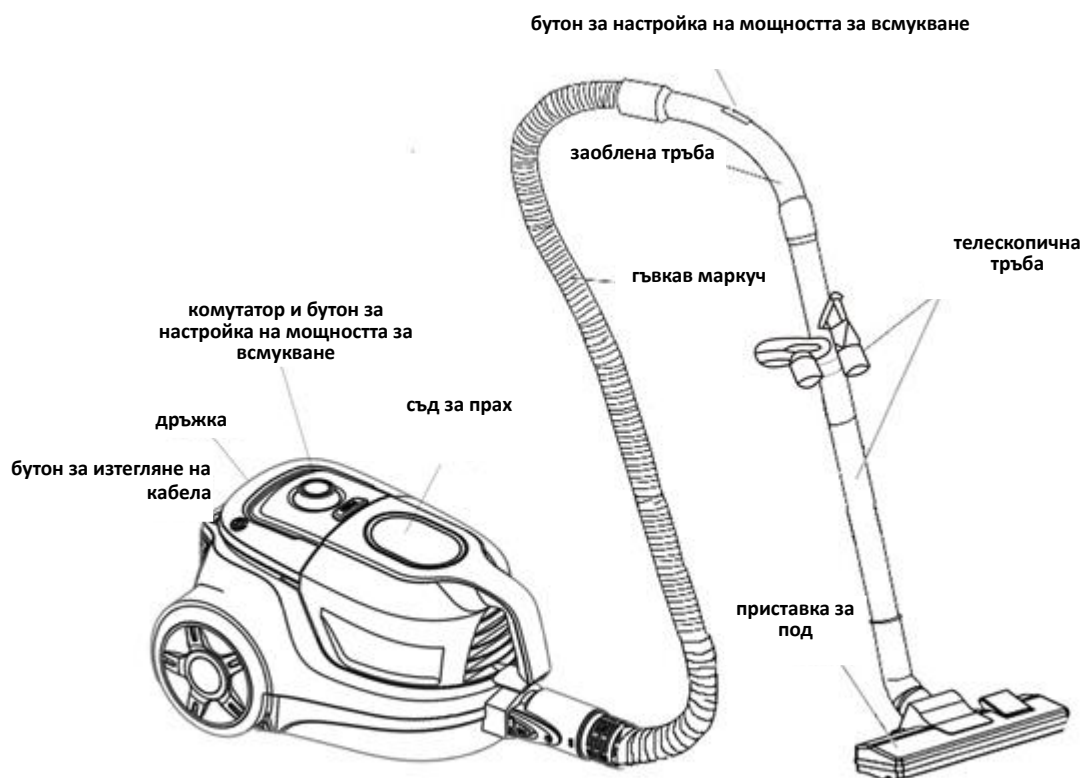

V. МЕРКИ ЗА БЕЗОПАСНОСТ

Уредът не е предназначен за използване от лица (включително деца) с намалени физически, сетивни или умствени проблеми, или с липса на опит и познания, освен ако са под наблюдение или са получили указания по отношение на използването на уреда от лице, което е отговорно за тяхната безопасност. Децата трябва да бъдат под наблюдение, така че да не си играят с уреда.



Ако захранващият кабел е повреден, той трябва да се подмени от производителя, сервизния персонал или от лица с подобна квалификация, за да се избегнат евентуални опасности. Този уред е предназначен само за домашна употреба.

Не всмуквайте прах за пране, бензин, стъкло, игли, пепел, вода, кибритени клечки и др.

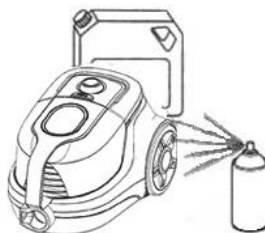

Уредът не трябва да се излага на топлина.

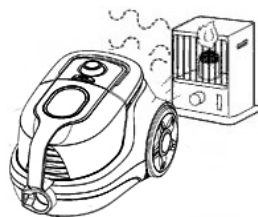

Изключете машината от източника за захранване с електроенергия.

След използване и преди извършване на всякакви операции за почистване на уреда, изваждайте щепсела на захранващия кабел от контакта, за да изключите уреда от източника за захранване с електроенергия.

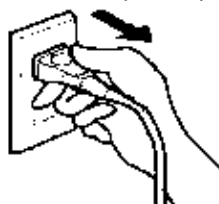

Не поставяйте предмети в отворите на уреда. Не използвайте уреда, ако някой от неговите отвори е запушен. Почиствайте уреда от прах, власинки, косми и др.

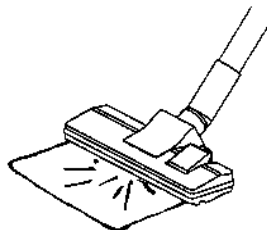

Не използвайте уреда без да е монтиран съда за прах или филтъра.

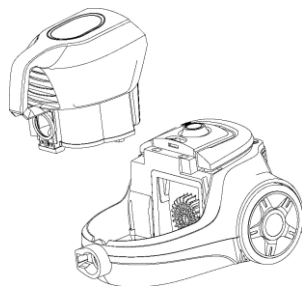

За предотвратяване на претоварването, не всмуквайте брашно, цимент и др.

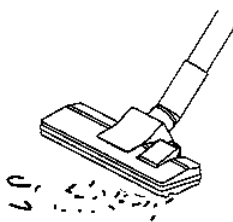

Уредът трябва да се почиства само със суха или влажна кърпа; уредът не трябва да се потапя във вода. Не използвайте разтворители за почистване.



VI. ИНСТРУКЦИИ ЗА УПОТРЕБА

Свържете маркуча към прахосмукачката

Поставете гъвкавия маркуч в отвора за всмукване. Натиснете бутона, докато се фиксира на едно място.

Извадете гъвкавата тръба: Извадете щепсела от контакта и натиснете върху бутона от края на маркуча. Извадете маркуча от отвора за всмукване.

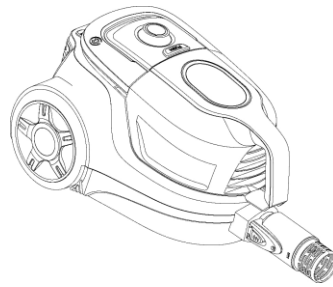

Монтирайте телескопичната тръба в заоблената тръба.

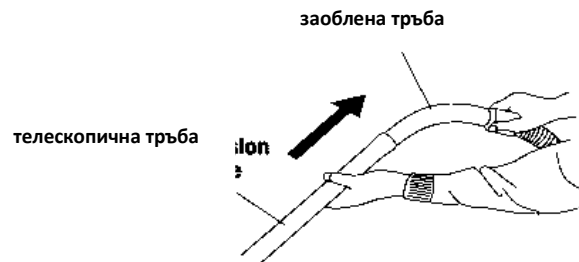

Фиксирайте четката за под в телескопичната тръба.

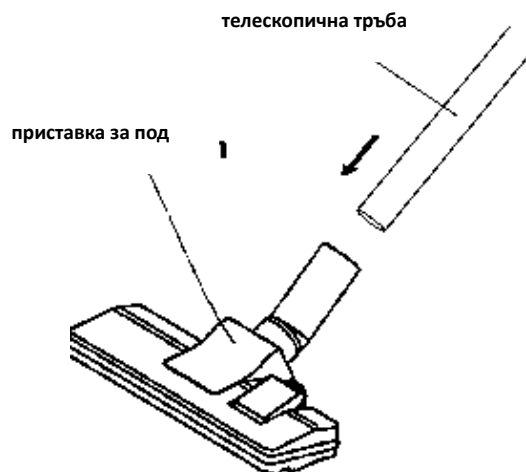

VII. ФУНКЦИОНИРАНЕ

Жълтият знак върху захранващия кабел показва препоръчителната дължина на кабела. Не изваждайте кабела след появяване на червения знак. За изтегляне на захранващия кабел, натиснете върху педала с една ръка и насочвайте кабела с другата ръка.



Натиснете върху бутона за ВКЛЮЧВАНЕ/ИЗКЛЮЧВАНЕ, за да включите уреда. Използвайте бутона за електронна настройка на мощността за всмукване.



Мощността за всмукване може да бъде настроена и с помощта на плъзгащата пластина върху заоблената тръба.



Тогава, когато правите пауза, можете да поставяте телескопичната тръба в куката за фиксиране. Внимание: Не транспортирайте уреда по време на използване на куката за фиксиране.

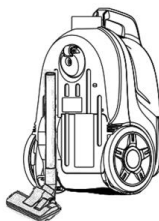

VIII. АКСЕСОАРИ ЗА ПОЧИСТВАНЕ

Аксесоар за тесни места:

Този аксесоар може да се използва за всмукване в ъгли на стаите, в чекмеджета, между мебели, за почистване на клавиатури, рафтове и прозорци.

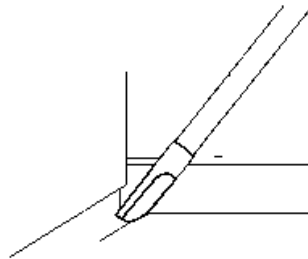

Четка за канапета: За почистване на легла, канапета и др.

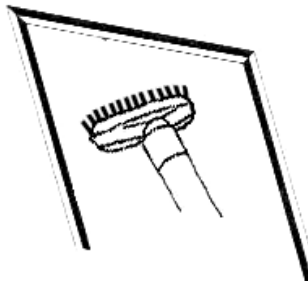

Използване на бутона за изваждане на четката: Четката се изважда с цел почистване на килими. Четката не се изважда с цел почистване на подове.

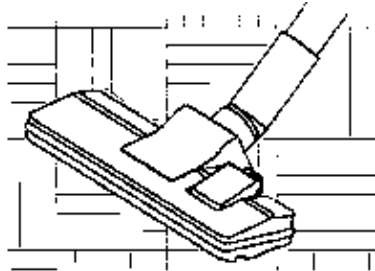
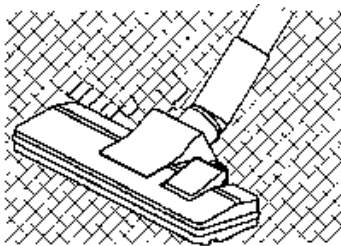

Ако заоблената тръба се запуши, поставете я в отвора за всмукване и включете уреда.

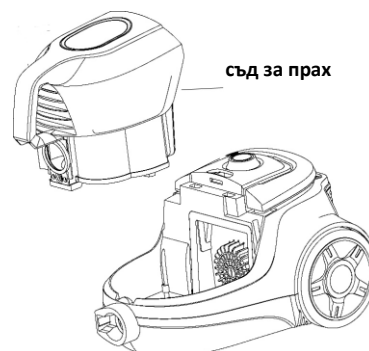

IX. ПОЧИСТВАНЕ И ПОДДРЪЖКА

Изпразване на съда за прах

1. След изваждане на гъвкавия маркуч, натиснете върху бутона за блокиране на капака и отворете съда за прах.
2. Извадете филтъра за прах от съда.
3. Позиционирайте отново филтъра за прах в съда.
4. Затворете съда за прах.

корпус на съда за прах

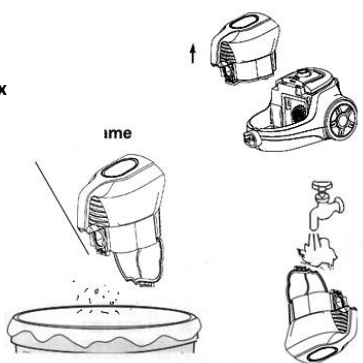

Смяна на филтъра

Мяна на филтъра на мотора: Отворете съда за прах и извадете филтъра на мотора. Фиксирайте нов филтър на място.

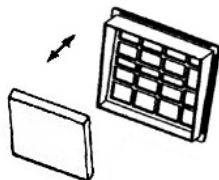

Смяна на филтъра за извеждане: Отворете решетката чрез дърпане, извадете филтъра за извеждане и сменете го с нов. Монтирайте решетката на място.

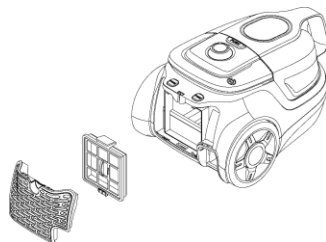

Почистване на филтъра: Почистете филтъра с вода и оставете го да изсъхне изцяло преди да го монтирате на място.

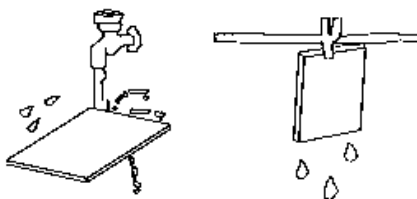

X. ОТКРИВАНЕ НА ПРОБЛЕМИ

Преди да се свържете със сервизен център проверете следното:

| Проблеми | Възможни причини | Необходими мерки |
|---|--|---|
| Моторът не се включва | <ul style="list-style-type: none"> - Щепселът не е включен по съответстващ начин в контакта - Електрическият контакт е повреден - Уредът не е включен | <ul style="list-style-type: none"> - Включете щепсела по съответстващ начин - Проверете контакта - Включете уреда |
| Всмукателната мощност е ниска | <ul style="list-style-type: none"> - Уредът е запушен - Филтърът за прах изисква почистване - Съдът за прах не е монтиран в правилната позиция - Филтърът е блокиран | <ul style="list-style-type: none"> - Отстранете причината за блокажа - Почистете филтъра за прах - Затворете съда за прах - Почистете филтъра |
| Кабелът не може да бъде изтеглен изцяло | Кабелът може да излезе от ролката | Дръпнете малко за кабела, след това оставете го да се изтегли |
| Кабелът не може да бъде изваден от уреда | Кабелът може да усукан върху ролката | Натиснете върху бутона за изтегляне на кабела и опитайте отново |
| Настройката на силата за всмукване не функционира | Уредът е повреден | Занесете уреда за ремонт (при специалист) |
| Захранващият кабел се прибира сам, без натискане на бутона. | Механизмът за изтегляне на кабела е повреден. | Занесете уреда за ремонт (при специалист) |
| Съдът за прах не може да бъде затворен | Филтърът за прах не е фиксиран по съответстващ начин | Фиксирайте филтъра за прах и опитайте отново |

Предупреждение:

Ако захранващият кабел е повреден, той трябва да се подмени от производителя, сервизния персонал или от лица с подобна квалификация, за да се избегнат евентуални опасности.

XI. ТЕХНИЧЕСКА ИНФОРМАЦИЯ

| | |
|------------------------------|------------------|
| Мощност: | 750W |
| Всмукателна мощност: | > 160W |
| Напрежение: | 220-240V~50/60Hz |
| Ниво на шум: | 75 dB |
| Обем на съда за прах: | 2.2 L |

**Изхвърляне на отпадъците по начин, отговорен за околната среда**

Можете да помогнете за опазването на околната среда!

Моля спазвайте местните разпоредби: Предайте нефункциониращото електрическо оборудване на център за събиране на отпадъци от електрическо оборудване.



HEINNER е регистрирана марка на компанията **Network One Distribution SRL**. Останалите търговски марки и наименованията на продуктите са търговски марки или регистрирани търговски марки на съответните им притежатели.

Нито една част от спецификациите не може да бъде възпроизвеждана под каквато и да е форма или средство, или използвана за получаване на производни като преводи, трансформации или адаптации, без предварителното съгласие на компанията NETWORK ONE DISTRIBUTION.

Copyright © 2013 Network One Distribution. Всички права запазени.

www.heinner.com, <http://www.nod.ro>

<http://www.heinner.com>, <http://www.nod.ro>



Този продукт е проектиран и произведен в съответствие със стандартите и нормите на Европейската общност.

Вносител: **Network One Distribution**

ул. Марчел Янку № 3-5, Букурещ, Румъния

Тел.: +40 21 211 18 56, www.heinner.ro, www.heinner.com

HEINNER

PORSZÍVÓ

Modell: HVC-V750BL

HVC-V750RD

HVC-V750OR



- Porszívó
- Teljesítmény: 750 W
- Szívó teljesítmény: > 160 W

Köszönjük, hogy ezt a terméket választotta!

I. BEVEZETÉS

A készülék használata előtt olvassa el figyelmesen a használati kézikönyvet, és őrizze meg későbbi tanulmányozásra.

A kézikönyvet azért szerkesztettük, hogy rendelkezésére bocsássunk a készülék üzembe helyezésére, használatára és karbantartására vonatkozó minden szükséges utasítást a.

A készülék helyes és biztonságos használata érdekében, az üzembe helyezés és használat előtt kérjük, olvassa el figyelmesen a használati kézikönyvet.

II. AZ ÖN CSOMAGJÁNAK TARTALMA

- Porszívó
- Padlókefe
- Szívófej
- Használati útmutató
- Garancialevél



III. A KÉSZÜLÉK LEÍRÁSA

1. Modern és elegáns dizájn.
2. A levegőszűrő rendszer egészséges takarítást biztosít.
3. Kellékek: padlókefék, szívófej stb.
4. Ergonomikus fekvésű pedál a kábel betekeréséhez.

IV. A KÉSZÜLÉK LEÍRÁSA

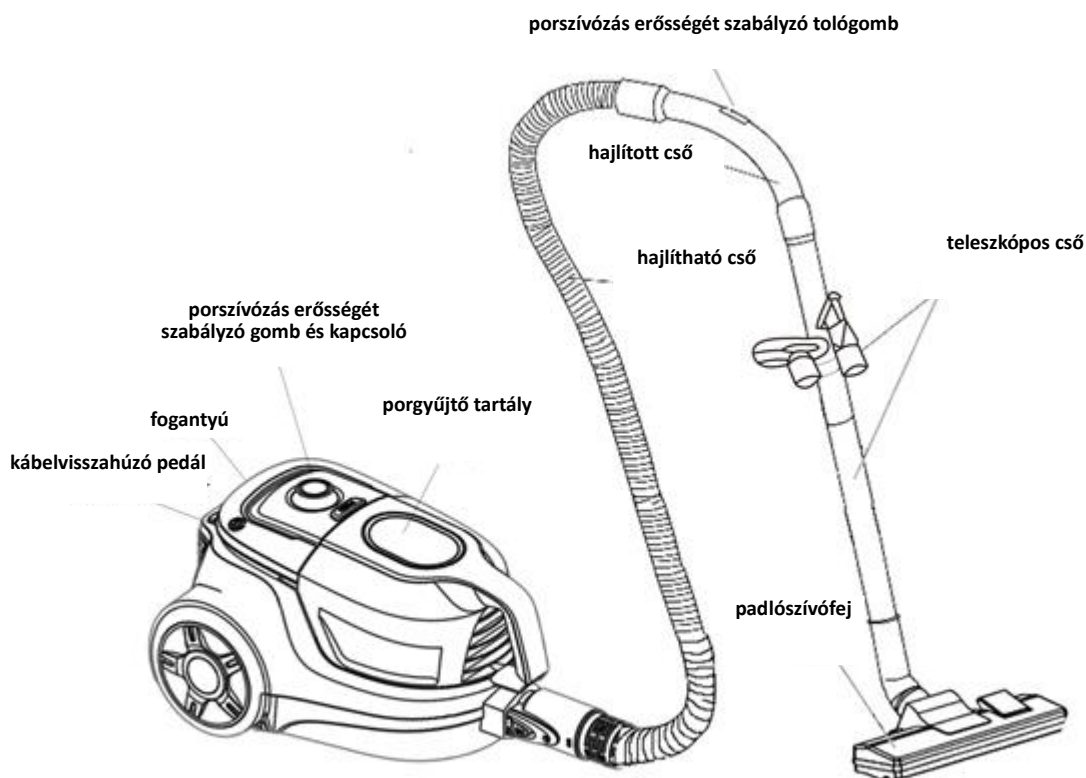

V. BIZTONSÁGI INTÉZKEDÉSEK

A készülék nem használható csökkent értelmi, érzékszervi, vagy fizikai képességű személyek által (gyermeket is beleértve), vagy olyanok által, akik nem rendelkeznek a kellő mennyiségű tudással és tapasztalattal, csak felügyelet mellett, vagy ha a felügyeletért és a biztonságukért felelős személy megtanította őket a helyes használatra.

A gyerekekre figyelni kell, nem kell engedni, hogy a készülékkel játszanak.



Abban az esetben, ha az elektromos tápkábel megsérült, azt a gyártó vagy az általa felhatalmazott szerviz vagy szakember kell cserélje hasonló módon. Ez a készülék kizárólag a háztartásban használható.

A porszívót ne használja vegyszerek, üzemanyag, üveg, tű, hamu, cigarettahamu, víz, gyufa felporszívójához.

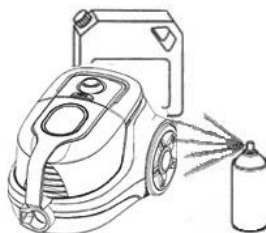

A készüléket ne tegyük ki hőforrásnak.

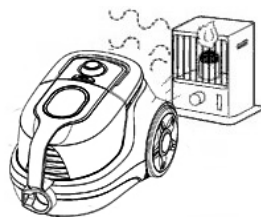

A karbantartási munkálatok elvégzése előtt csatlakoztassa le a készüléket a tápforrásról.

Minden használat után és a készülék bármely részének a tisztítási folyamata előtt húzza ki a dugaszt a fali csatlakozóaljzatból annak érdekében, hogy a készülék áramtalanítva legyen.

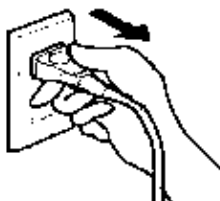

Ne dugjon tárgyakat a készülék résein. Ne használja a porszívót, ha bármely nyílása el van dugulva. A készülékre lerakódó port, szálcsomókat, hajat stb. le kell takarítani.

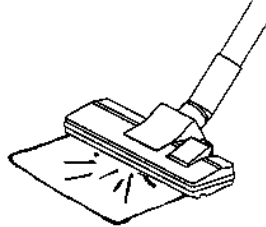

Ne használja a porszívót, ha a porzsák vagy a szűrő nincs felszerelve

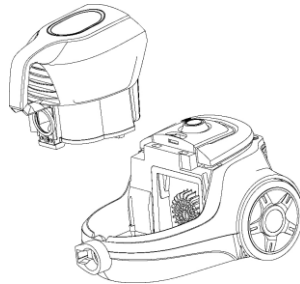

A túlterhelés elkerülése érdekében ne használja a készüléket liszt, cementpor stb. felporszívózásához.

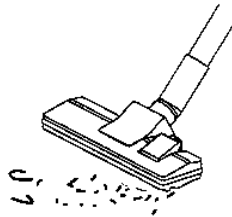

A készüléket száraz vagy nedves törölkendővel kell tisztítani; soha ne tegye bele vízbe. A tisztításhoz ne használjon oldószereket.



VI. HASZNÁLATI ÚTMUTATÓ

Csatlakoztassa a gégecsövet a porszívóhoz

Helyezze be a gégecsövet a szívónyílásba. Nyomja le a gombot, amíg megfelelően rögzül.

Vegye ki a gégecsövet: Húzza ki a dugaszt a fali csatlakozóaljzattól és nyomja le a gégecső végén levő gombot. Vegye ki a gégecsövet a szívónyílásból.

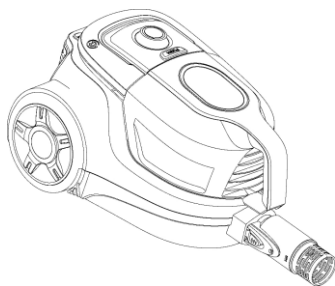

Csatlakoztassa a teleszkópos csövet a hajlított csővel.

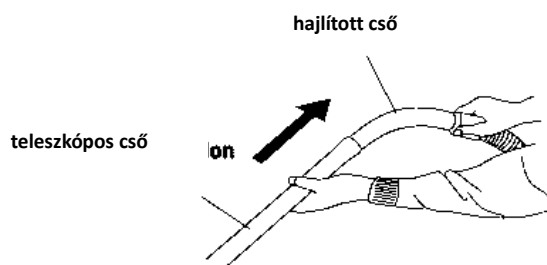

Rögzítse a padlókefét a teleszkópos csőhöz.

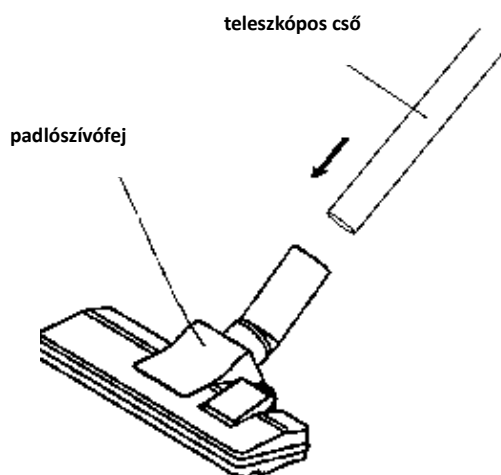

VII. MŰKÖDÉS

A tápkábelen levő sárga jelzés az ajánlott kábelhosszúságot jelzi. Ne húzza ki jobban a kábelt, ha elérte a piros jelzést. A tápkábel visszatekeréséhez az egyik kezével nyomja le a pedált, a másik kezével segítse a kábelt.

kábelvisszahúzó pedál

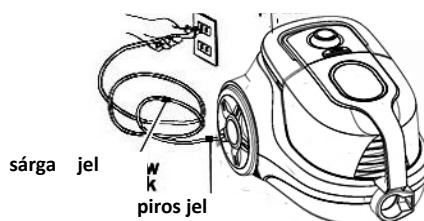

Nyomja le a BEKAPCSOLÁS/KIKAPCSOLÁS gombot, a készülék el fog indulni. Használja a szívóteljesítmény elektronikus beállítására szolgáló gombot.



A szívásteljesítmény beállítható a hajlított csőrészen található csúszzófedél segítségével is.

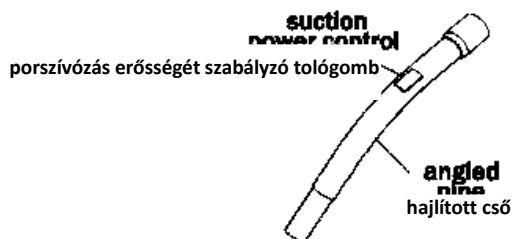

Ha szüneteltetné a porszívózást, a teleszkópos csövet a tartókampóba állíthatja. Figyelem: Ne szállítsa a készüléket, ha tartókampóba helyezte a csövet.

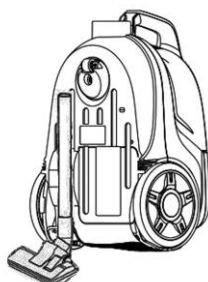

VIII. TAKARÍTÁSHOZ SZÜKSÉGES KELLÉKEK

Nehezen hozzáférhető résekhez tervezett tartozék:

Ezt a tartozékot a szobák sarkának, fiókok, bútordarabok közti keskeny terek, billentyűzetek, polcok és ablakok porszívózásához használhatja.

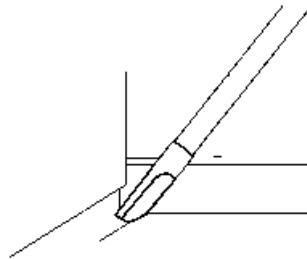

Kárpitkefe: Ágyak, kanapék stb. tisztításához.

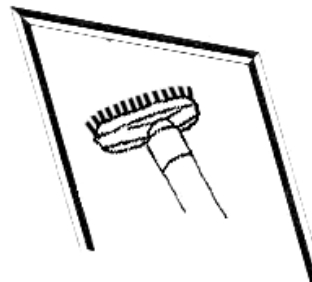

A kefe hosszabbításához szükséges pedál használata: Szőnyegtisztítás esetén a kefe megnagyobbítható. Padló tisztítása esetén a kefét nem szükséges meghosszabbítani.

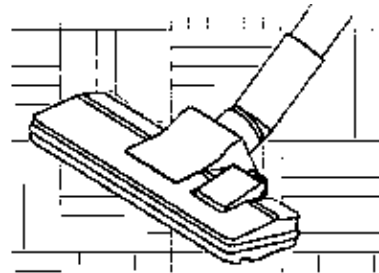
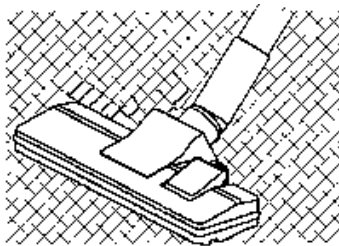

Ha a hajlított cső eldugul, helyezze be a szívónyílásba és indítsa el a készüléket.

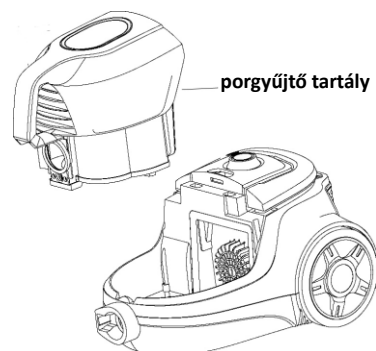

IX. TISZTÍTÁS ÉS KARBANTARTÁS

A porgyűjtő kiürítése

1. A gégecső eltávolítása után nyomja le a porgyűjtő edényt tetejét rögzítő gombot és nyissa ki a porgyűjtő edényt.
2. Vegye ki a porszűrőt az edényből.
3. Helyezze vissza a porszűrőt az edénybe.
4. Csukja le a porgyűjtő edényt.

porgyűjtő tartály váza

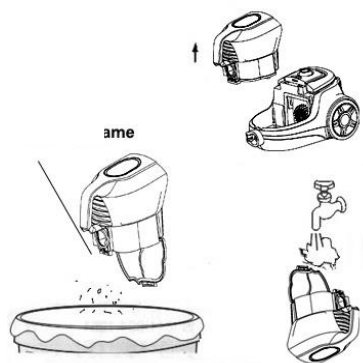

A szűrő cseréje

A motor szűrőjének cseréje: Nyissa ki a porgyűjtő edényt és vegye ki a motort védő szűrőt. Helyezzen be egy új szűrőt és rögzítse megfelelő módon.

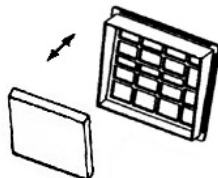

A levegőkifúvó szűrőjének cseréje: Húzza meg és vegye le a rácsot, vegye ki a kifújt levegő szűrőjét és cserélje ki egy új szűrővel. Helyezze vissza a rácsot.

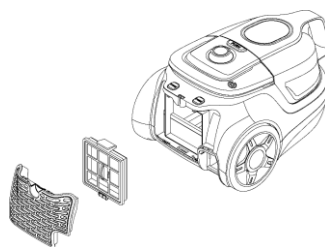

A szűrő tisztítása: A szűrőt tisztítsa meg vízzel és várjon, amíg teljesen kiszárad, csak szárazan helyezze vissza a készülékre.

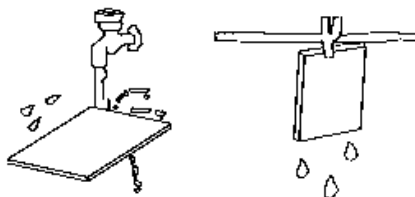

X. A HIBÁK BEAZONOSÍTÁSA

Mielőtt kapcsolatba lépne a szervizközponttal, ellenőrizze a következőket:

| Probléma | Lehetséges okok | Szükséges intézkedések |
|--|--|---|
| A motor nem indul | - A dugasz nincs megfelelő módon csatlakoztatva a fali csatlakozóaljzathoz - Hibás a fali csatlakozóaljzat - A készülék nincs bekapcsolva | - Csatlakoztassa megfelelő módon a dugaszt - Ellenőrizze a fali csatlakozóaljzatot - Indítsa el a készüléket |
| A készülék szívóereje csökkent | - A készülék eldugult - A porszűrő tisztításra szorul - A porgyűjtő edény nem megfelelő pozícióban van felszerelve - A szűrő elzáródott | - Távolítsa el az elzáródás okát - Tisztítsa meg a porszűrőt - Csukja le a porgyűjtő edényt - Tisztítsa meg a szűrőt |
| A kábel nem csavarodik vissza teljesen. | A kábel lejöhet a hengerről. | Picit húzza meg a kábelt, majd hagyja, hogy tekeredjen vissza. |
| A kábel nem húzható ki a készülékből. | A hengeren a kábel összezsavarodhatott. | Nyomja le a kábel visszacsavaró gombját, majd próbálkozzon ismét. |
| A szívóerő beállítása nem működik | A készülék meghibásodott | Vigye készülékét javítóműhelybe (szakemberhez) |
| A tápkábel magától visszatekeredik, anélkül, hogy a visszatekerő gombot lenyomnánk | A kábel-visszatekerő szerkezet meghibásodott | Vigye készülékét javítóműhelybe (szakemberhez) |
| A porgyűjtő edény tetejét nem lehet lecsukni | A porszűrő nincs megfelelő módon behelyezve | Rögzítse a porszűrőt és próbálja meg újra |

Figyelmeztetés:

A veszély elkerülése érdekében, amennyiben a tápkábel sérült, ezt ki kell cseréltetni a gyártó, a gyártó szervizügynöke, vagy hasonló szakképesítéssel rendelkező személy által.

XI. TECHNIKAI LEÍRÁS

| | |
|------------------------------------|------------------|
| Teljesítmény: | 750W |
| Szívó teljesítmény: | > 160W |
| Feszültség: | 220-240V~50/60Hz |
| Zajszint: | 75 dB |
| Porgyűjtő edény űrtartalma: | 2.2 L |

**A hulladékok környezetfelelős eltávolítása**

Segíthet a környezet védelmében!

Kérjük, tartsa be a helyi rendelkezéseket: a nem működő elektromos berendezéseket a használt elektromos hulladékokat gyűjtő központba szolgáltatassa be.



A HEINNER a **Network One Distribution SRL(KFT)** társaság által bejegyzett védjegy. A többi márkajelzés és a termékek megnevezése kereskedelmi vagy az illető birtoklók által bejegyzett márkanevek.

A műszaki leírások egyik része sem reprodukálható semmilyen formában és semmilyen módon, és nem használható fel fordításra, átváltoztatásra vagy alkalmazásra a NETWORK ONE DISTRIBUTION társaság előzetes bejegyzése nélkül.

Copyright © 2013 Network One Distribution. Minden jog fenntartva.

www.heinner.com, <http://www.nod.ro>

<http://www.heinner.com>, <http://www.nod.ro>



A terméket az Európai Közösség előírásainak és jogszabályainak megfelelően tervezték és gyártották.

Importőr: **Network One Distribution**

Marcel Iancu utca, 3-5 szám, Bukarest (București), Románia

Tel: +40 21 211 18 56, www.heinner.ro, www.heinner.com